

DynaMask: Dynamic Mask Selection for Instance Segmentation

Ruihuang Li^{}, Chenhang He^{*}, Shuai Li, Yabin Zhang, Lei Zhang[†]*

¹The Hong Kong Polytechnic University

Code: <https://github.com/lslrh/DynaMask>



Background

Motivation

Low-resolution: lose rich details

High-resolution: incur quadratic computation overhead

We aim to **dynamically select suitable masks for different object proposals.**

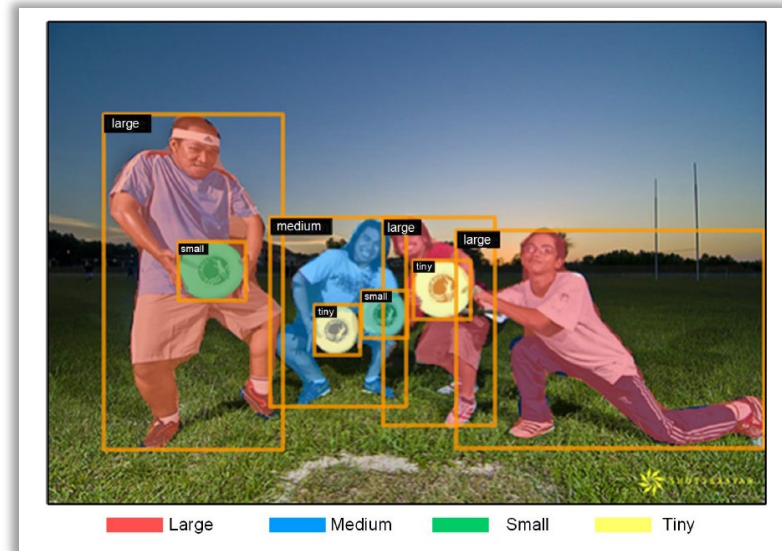

Method

- Dual-level FPN
Image-level FPN & Region-level FPN

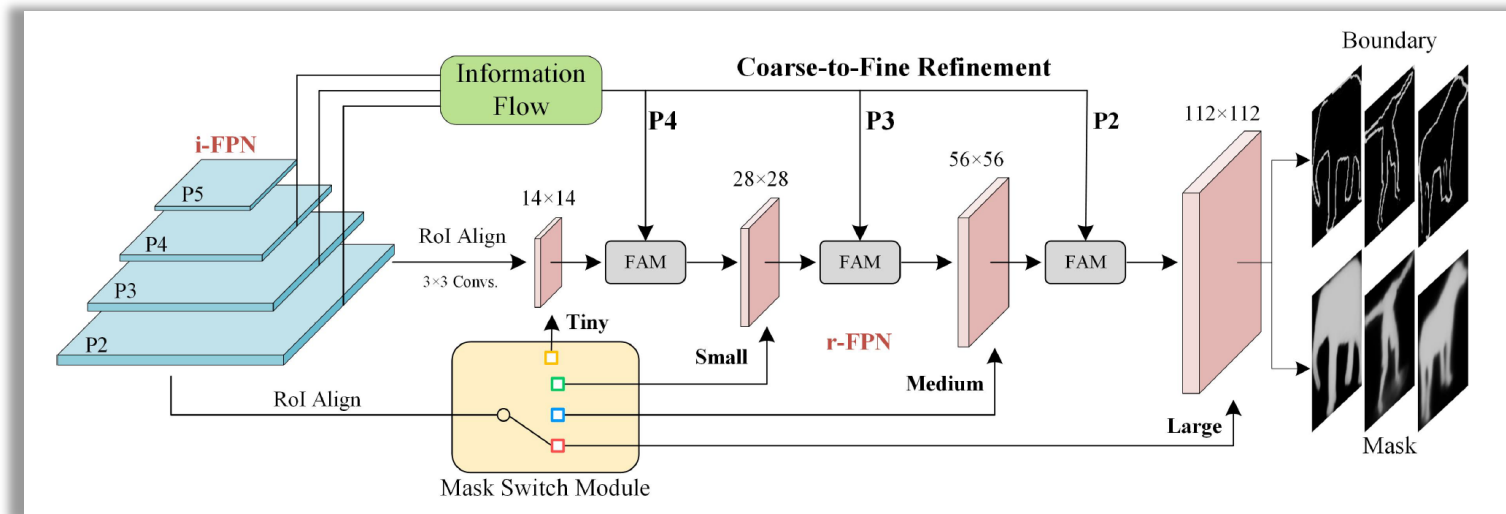

Method

- Mask Switch Module (MSM)

Optimal Mask Assignment MSM takes the cropped region-wise RoI feature as input and outputs a probability vector

$$p^k = \frac{\exp(f_{MSM}^k(x))}{\sum_{k'} \exp(f_{MSM}^{k'}(x))}, \quad k \in \{1, \dots, K\},$$

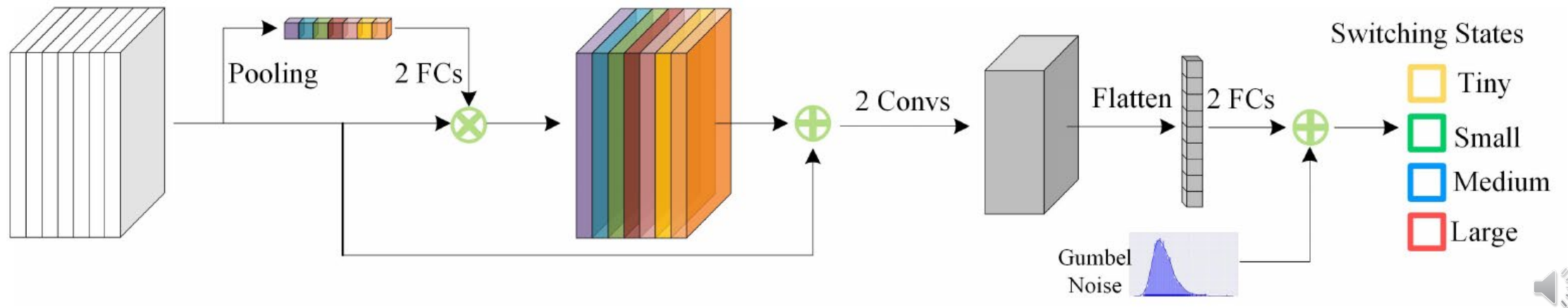

Method

- Objective Function

Edge Loss

$$\mathcal{L}_{edge} = \sum_{i=1}^N \sum_{k=1}^K y^k \ell(\hat{e}_i^k, e_i),$$

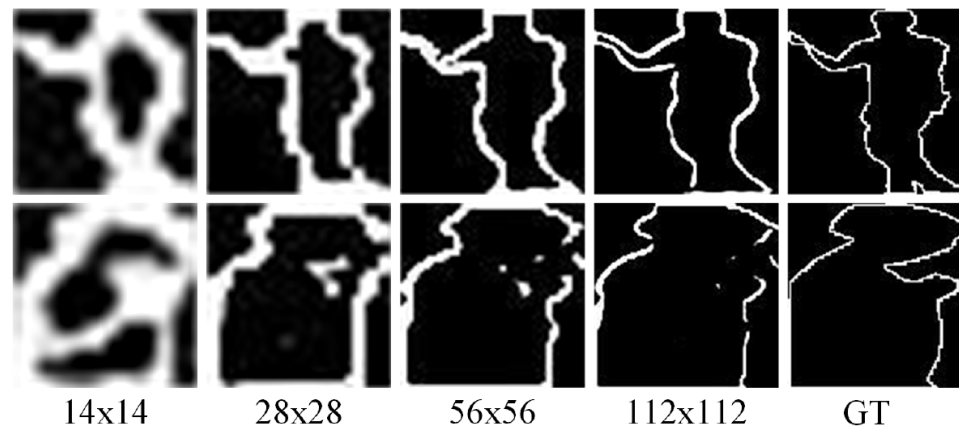

Budget Constraint

$$\mathcal{L}_{budget} = \max\left(\frac{\mathbb{E}(\mathcal{C})}{\mathcal{C}_t} - 1, 0\right).$$



Experiments

- Qualitative results

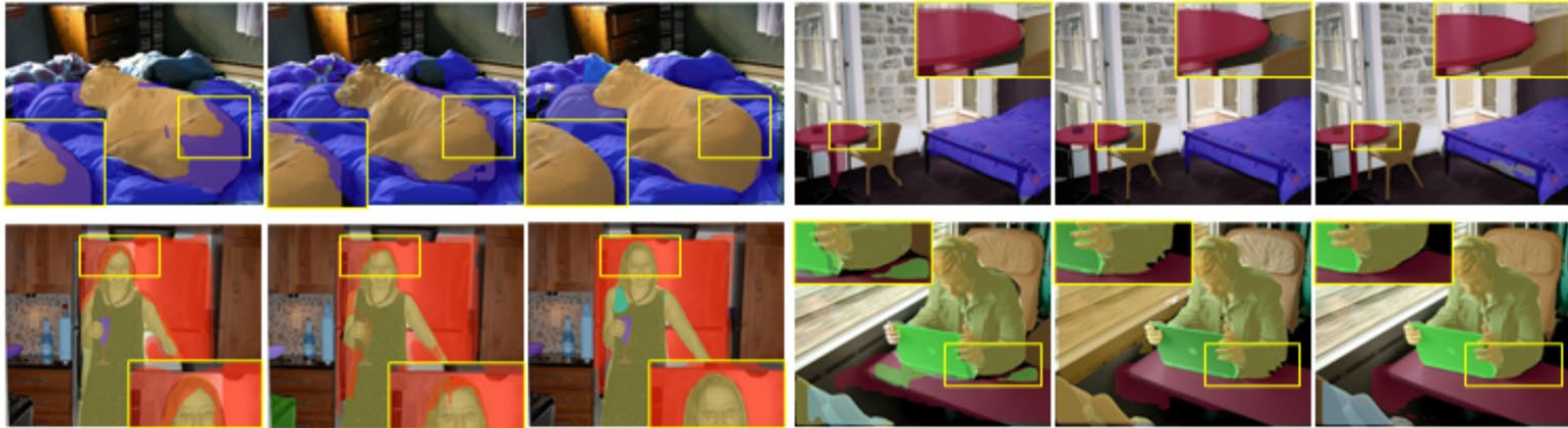

Experiments

- Comparisons with state-of-the-art methods

Method	Backbone	sched.	AP	AP ₅₀	AP ₇₅	AP _S	AP _M	AP _L
MEInst [31]	ResNet-101-FPN	3×	33.9	56.2	35.4	19.8	36.1	42.3
Mask R-CNN [10]	ResNet-101-FPN	3×	38.5	60.0	41.6	19.2	41.6	55.8
BMask R-CNN [6]	ResNet-101-FPN	1×	37.7	59.3	40.6	16.8	39.9	54.6
TensorMask [5]	ResNet-101-FPN	6×	37.1	59.3	39.4	17.4	39.1	51.6
Mask Scoring [14]	ResNet-101-FPN	18e	38.3	58.8	41.5	17.8	40.4	54.4
CondInst [26]	ResNet-101-FPN	3×	39.1	60.9	42.0	21.5	41.7	50.9
BlendMask [2]	ResNet-101-FPN	3×	38.4	60.7	41.3	18.2	41.5	53.3
PointRend [17]	ResNeXt-101-FPN	3×	41.4	63.3	44.8	24.2	43.9	53.2
SOLOv2 [28]	ResNet-101-FPN	6×	39.7	60.7	42.9	17.3	42.9	57.4
HTC [3]	ResNet-101-FPN	20e	39.7	61.8	43.1	21.0	42.2	53.5
DCT-Mask [†] [25]	ResNet-101-FPN	3×	40.1	61.2	43.6	22.7	42.7	51.8
RefineMask [30]	ResNet-101-FPN	3×	39.4	-	-	-	-	-
Mask Transfuser [†] [16]	ResNet-101-FPN	3×	40.7	-	-	23.1	42.8	53.8
QueryInst [†] [9]	ResNet-101-FPN	3×	41.7	64.4	45.3	24.2	43.9	53.9
DynaMask	ResNet-101-FPN	3×	39.6	61.4	42.9	21.2	42.4	53.2
DynaMask [†]	ResNet-101-FPN	3×	41.3	62.5	45.2	22.8	43.4	54.0
DynaMask [†]	ResNeXt-101-FPN	3×	42.0	62.9	46.3	23.4	44.0	54.8



Experiments

- Mask Selection Results

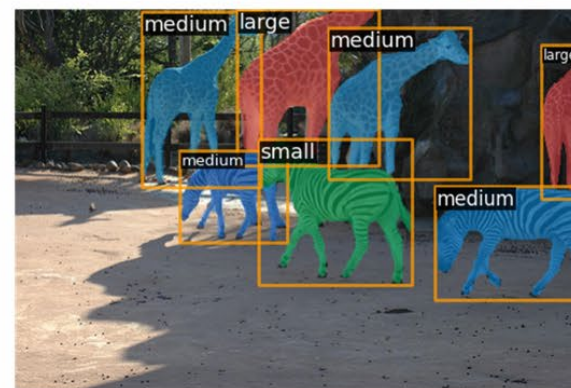
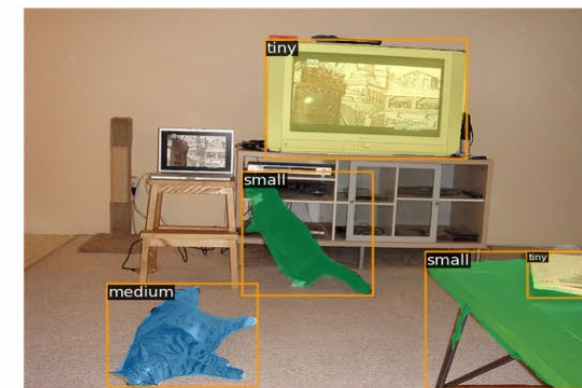
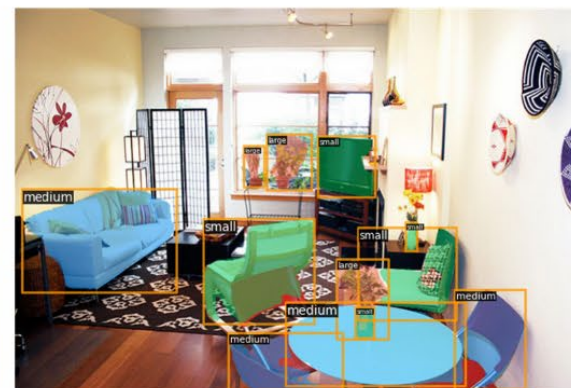
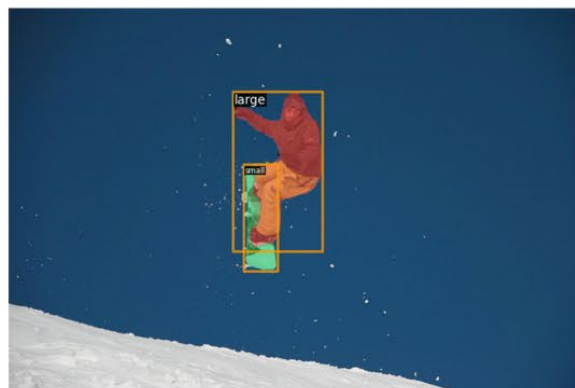



The End

Thanks!

